

Article number: 2032100M12125A1S

Description: E+G levelling foot
GN 32-100-M12-125-A1-S

Note: S Without nut, External hexagon at the bottom

Measures

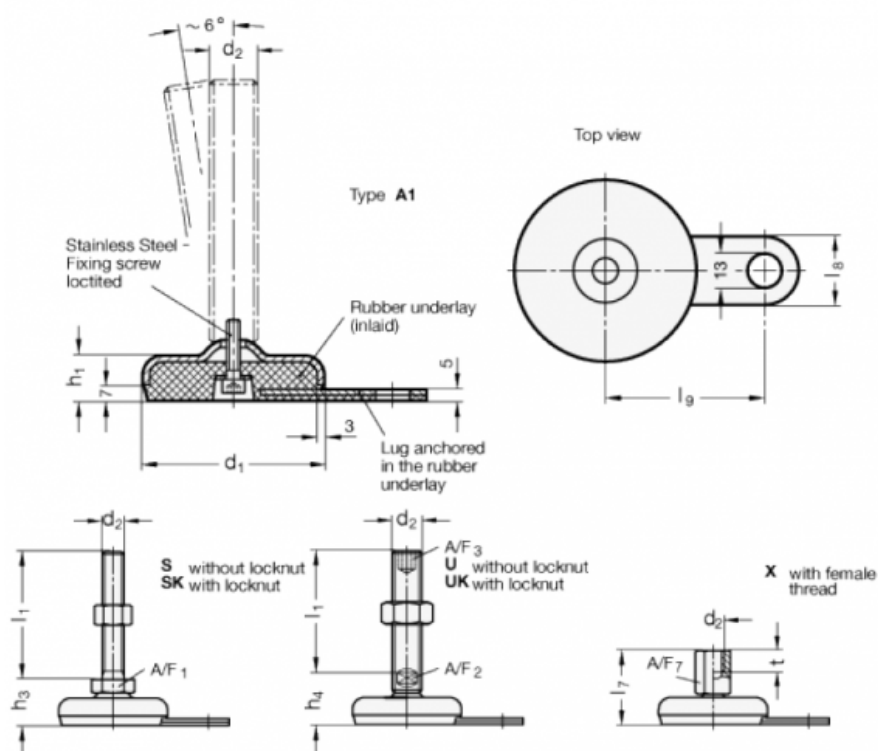

A/F1	=	17
d1	=	100
d2	=	M12
h1	=	21
h3	=	29
l1	=	125
l8	=	30
l9	=	80